

Smart Toilet Manual

Model

Thanks for choosing our product

And please read the instructions carefully before using.

The pictures are for reference only, please refer to the actual product

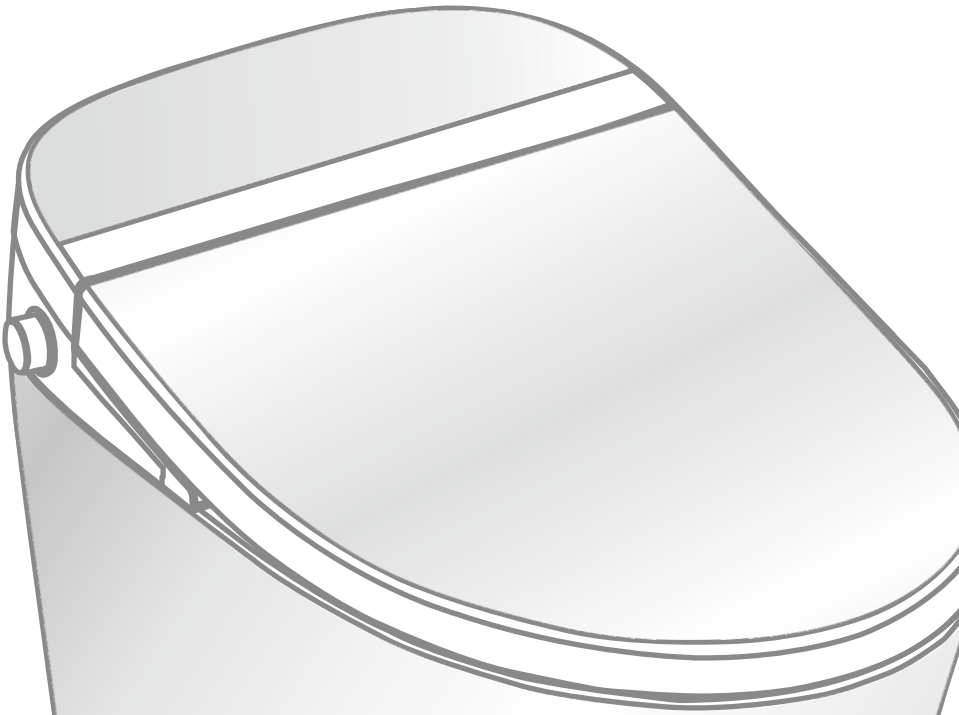

Contents

Before use

Safety precautions	1
Overall sketch	6
Function introduction	7

Installation guide

Toilet installation	8
Remote control bracket installation	11

Operation

Operation introduction	12
Preparation	12
Product use	13
Troubleshooting	19
Cleaning and Maintenance	20



Appendix

Product specification	24
Packing list	25



Safety precautions



Please read the “safety precautions” carefully before use, all the precautions listed here are connected to safety. It's important and must be followed.

Sign and meaning

	Warning	Represents improper operations by ignoring the instructions may result in death or injury
	Notice	Represents improper operations by ignoring the instructions may result in body injury and property loss

The following signs are used for important safety precautions.

Sign	meaning
	It represents not allowed, “forbid”
	It represents enforced to do

 WARNING	
	<p>Please do not touch the electrical outlet with wet hand</p> <ul style="list-style-type: none"> • Or it may cause electric shock <p>Please do not pour water, hot water or detergent on the top of the toilet and electrical outlet</p> <ul style="list-style-type: none"> • Or it may cause fire, electric shock, heat or short circuit • Or it may cause injury and indoor water seepage because of the damage of product <p>Never attempt to disassemble, repair, or alter the product yourself.</p> <ul style="list-style-type: none"> • Or it may cause fire, electric shock, heat or short circuit <p>Please do not install the toilet in car, ship or any other moving object.</p> <ul style="list-style-type: none"> • Or it may cause fire, electric shock, short circuit or fault. • Or the ceramic, seat and main part will be damaged because of falling down. <p>Stop using while it breakdown</p> <p>Under the following condition, please disconnect the power supply and turn off the water angle valve</p> <ul style="list-style-type: none"> — Water leakage from pipe or inside of the product — crack or damage on the product — unusual sound or smell — Smoke — Unusual heating — Block — Fall out of the cushion <ul style="list-style-type: none"> • Continue using the toilet by ignoring the faults may result in fire, electric shock, heat, short circuit, injury and indoor water seepage



WARNING



Please don't use seawater and other water except tap water or drinkable well water(underground water)

- Or it may cause skin inflammation or fault

Please do not touch the electrical plug while thunder

- Or it may cause electric shock

Please do not let the water inlet soft pipe connect to the electrical plug and outlet

- Or it may cause fire, electric shock, heat, short circuit because of moisture condensation

Please do not destroy power cable or plug

Does not strike, yank, twist, excessively bend, damage, or alter the electrical cords. Also, do not place anything heavy on, bind or pinch the cords.

- Or it may cause fire, electric shock, heat and short circuit if it's broken

Please do not use a loose or faulty electrical outlet.

- Or it may cause fire or short circuit.

Please use the electrical outlet and wire appliance in specified area.

- Or it may cause fire because of wire appliance is not in the rule of outlet.

Please do not use any power supply other than AC 220v,50Hz. 120V,60Hz

- Or it may cause fire or heat.

Please do not put finger or anything else into the warm air outlet.

Please do not put objects or clothes on the air outlet or cover it.

- Or it may cause scald, electric shock or accessories burn down.

Please keep cigarettes and other open flames away from the product

- Or it may cause fire.



Pay attention to the low temp scalding

- Improper use of warm seat may cause low temp scalding.

If you sit for long time, please turn the temp setting to "off" level.

Please turn the seat temp setting to "off" level, warm air dry temp to "low" level under following situations.

- Children and elders those who can not adjust the temp to the proper level
- Patient and disabled people those who have problem in behavior.
- People who have take medicine with hypnosis effect(hypnotics, cold cure and etc), or are excessive drinking, too tired and somnolence.

This is an electrical product, please do not install it in a place where is easily get wet or with high humidity. If installed in bathroom, please also install ventilator to maintain the bathroom ventilation.

- Or it may cause fire or electric shock.

The product must be connected to cold water supply.

- Or it may cause body burn or machine fault.

The product must be connected to the ground correctly.

- If not connected to the ground, it may cause electric shock.

The ground processing here requires the ground resistance under 100Ω, the earth wire of switchboard is over Ø1.5mm, with copper material. (please entrust installation company to do the job)



WARNING

Please confirm if the electrical outlet is connected to the ground

- Or it may cause electric shock because of fault or short circuit.

The outlet for power wire should obey the following rules.

- Or it may cause fire or electric shock.
 - a. Please use high sensibility and fast response leakage switch (rated induced currents below 15mA) or insulating transformer (1.5kVA~3kVA) to protect outlet loop.
 - b. Please reserved the installation place for outlet and keep it away from bathtub.
- * Please confirm above a, b wiring projects are finished. Or please entrust the engineering contractor to do this job.

The electrical plug should be inserted to the outlet firmly.

- Or it may cause fire, heat or short circuit.

Please hold the plug not the wire when pulling out the plug.

Please do not grasp the wire to pull out the plug.

- Or it may cause fire or heat because of broken wire.

If the power soft wire is broken, to avoid danger, please ask the maintenance department of company or similar departments to replace it.

Please be sure to turn off the power while doing the maintenance or spot check.

- Or it may cause electric shock or accessories burn down.
- * Not include "nozzle clean"

Disabled people or who is lack of experience or common sense (including children) should be accompanied with personnel guardian while using this product.

- Or it may cause scald, electric shock, fire and body injury.

Please do not let children play this product.

- Or it may cause scald, electric shock, fire and body injury.

Do not throw lighted cigarettes and other flaming material into the toilet.

- Or it may cause fire.





NOTICE

Please do not use the product when it's loose.

- Or the toilet and seat may separate and fall off to cause body injury

Please do not touch broken area.

- Or it may cause injury, please replace it as soon as possible.

Please do not impact forcefully, put heavy subject or stand on the product

- Or it may cause product damage, fall down or body injury
- Or it may cause body injury or indoor water seepage

Please do not pull the product by holding the seat or cover.

Please do not open the seat and cover when something on the product.

- Or the main body may fall off to cause body injury.

Please use kitchen detergent(neutral) to maintain the plastic part(seat cover, etc) and water inlet soft hose, please do not use the following materials [bathroom detergent, house detergent, gasoline, banana oil, cleaning powder and nylon brush and so on]

- Or it may damage the plastic parts, cause cracks to body injury for fault
- Or it may cause water leakage because of damaged soft hose

To avoid sudden water leakage, please do not remove the water inlet filter when angle valve is open

[please refer to cleaning instruction of water inlet filter]

- Or the water may spray out

Please do not crush or bend water inlet hose

- Or it may cause water leakage

Please use the new hose that put inside the accessory box, the old one isn't recycled.

- Or it may cause water leakage

Please do not pour hot water into toilet

- Or it may cause body injury or indoor water seepage because of toilet damage

Please do not flush with big amount of toilet paper or other subjects except sewage and small amount toilet paper.

- Or it may cause body injury or indoor water seepage because of toilet damage

Please do not lean on the toilet cover while using

- Or it may destroy the seat cover.



 **NOTICE**

Please close the angle valve when water leaking

When room temp is under 0°C, to avoid piping or soft hose damaging because of frozen, anti freezing measures should be adopted.

- It may destroy main body or piping, leading to water leakage if water inlet soft hose is frozen.
- To avoid damage, please pay attention to room temp adjustment.

When not use for a long time, please must drain the inlet soft hose, and cut the power.

- When using next time, please open the angle valve and let water connected first. or it may cause skin inflammation because of bad water quality.
- It may cause fire or heat if the power supply is always connected.



Please must confirm if the filter has screwed to right position when install it.

- It may cause water leakage if not screwed tight.

When the toilet drain outlet is blocked, cut off the power then clean the obstruction

- Or the sewage may overflow, cause indoor water seepage because of auto flush function.
- Use the professional tools sold in the market to clean the obstruction.

Flush the toilet after pee

- Or it may cause difficulty in clean the toilet, block the drain outlet or sewage overflow, result in indoor water seepage.

Use the dried towel to clean the pee, dee, detergent, water and etc on the floor.

- Or it may leave dirt on the floor or corrode the floor.

 **NOTICE**

This bidet refer to GFCI outlet, doesn't use extension cord.

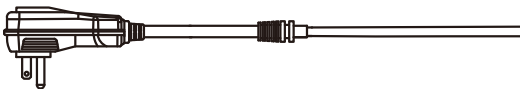

Overall Sketch

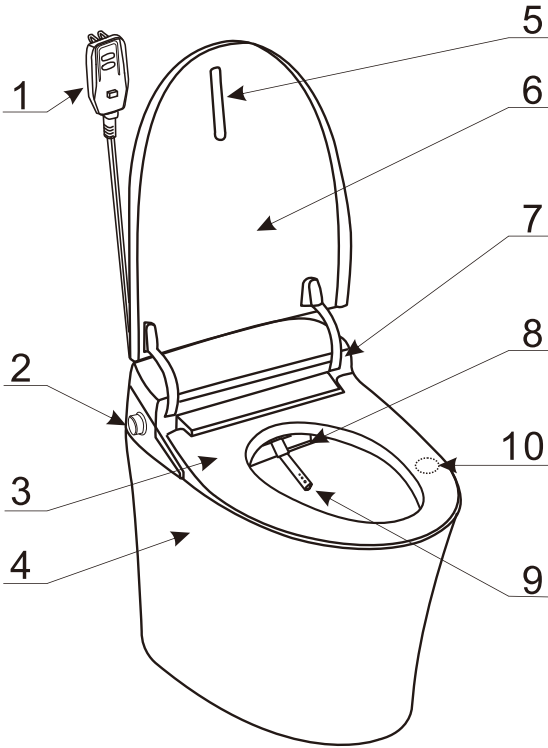

- 1 Power plug (Electric Leakage Protection)
- 2 Side knob
- 3 Heated seat
- 4 Toilet bowl
- 5 Cushion pad
- 6 Toilet lid
- 7 Damper
- 8 Dryer outlet
- 9 Nozzle
- 10 Sensing area

Remote control

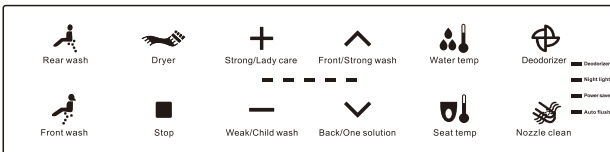

NOTICE

The contents described in this manual include but are not limited to product material, process, functional characteristics, etc., which may be different from the actual product due to process improvement or product upgrade. Please refer to the actual product.

Functions introductions

Function	Introduction
Rear wash	Provide rear cleansing
Rear oscillating Wash	Move the nozzle back and forth for rear cleansing
Front wash	Provide cleansing by front cleansing nozzle with a gentle spray
Front oscillating Wash	Move the nozzle back and forth with a gentle spray
Child wash	Children's special warm water gentle cleaning
One solution	Auto clean, flush and dry
Strong wash	Large amount of water to clean the buttocks to promote laxative
Lady care	Special cleaning of female's physiological period
Nozzle position adjustment	Adjust the suitable washing positions
Temperature adjustment	Set the temperature of seat and water
Water pressure adjustment	Change cleaning water pressure
Seat sensor	Functions activated by sitting on the seat
Drying	Dry the users after cleansing
Movable drying	Move the air outlet back and forth for drying
Changing drying intensity	Control the temperature of warm air from the dryer
Warm air position adjustment	Set the position of air outlet
Nozzle self-clean	Provide nozzle self-cleaning before washing
Smart remote control	Use the remote control to set up and control the toilet
Deodorizer	Removing odors
Saving energy	Saves electricity
Night light	Preparations for insufficient light
Soft close	Damper in the seat and cover, to make it close softly
Auto flush	Auto bowl unit cleaning after users walk away
Power switch	Turn power on and off
Flush even if power off	Push side button to flush when power off
Ceramic bowl pre-wet	Water come out of the nozzle to make the ceramic bowl wet
Foot sensor flush*	When the foot has crossed the sensor switch at the bottom, the flushing function is activated.

*Remark: Function is different depending on the model configuration

Installation method

◆ Toilet installation ◆

※ Installation Conditions

Please check that walls and floors in the toilet room are finished construction and there is enough space pre-arranged for sewage, electric wires and water lines. Also please confirm the distance from the closet flange centerline to the fished wall fits for the pit length. And the water supply pressure should be within a range of 0.1MPa (dynamic)-0.75Mpa (static). While the water supply temperature should be within a range of 5°C-35°C.

Notice: Please confirm the water inflow is greater than 18l/min, otherwise it may not be performed.

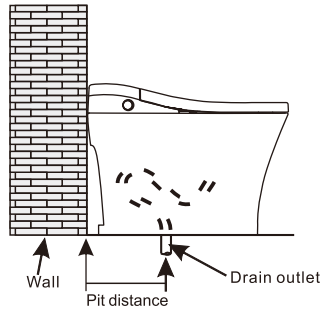

※ Install the Water Supply

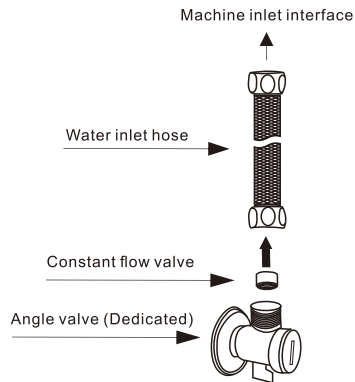
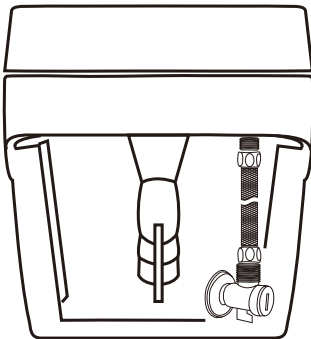

Tips:

1. Please install the constant flow valve correctly, otherwise it will cause abnormalities such as splashing and unstable water consumption.
2. When the water supply pressure is low, the flushing effect will be worse. At this time, it is recommended to remove the constant flow valve and install an inline pump.

※ Install the Water Supply

1. Drain the dirt in the pipe before the installation of the toilet.
2. Install the special angle valve in the accessories into the tap water pipe.
3. Connect the valve with inlet hose.
4. Open the valve to check water leakage in all parts.

Notice: The dirt in the water pipe may clog the inner spool of the product and seriously affect the function. PE pipe's material is plastic. Please avoid the use in direct sunlight or high temperature environment. We recommended to replace every 2 years.

※ Install the Toilet

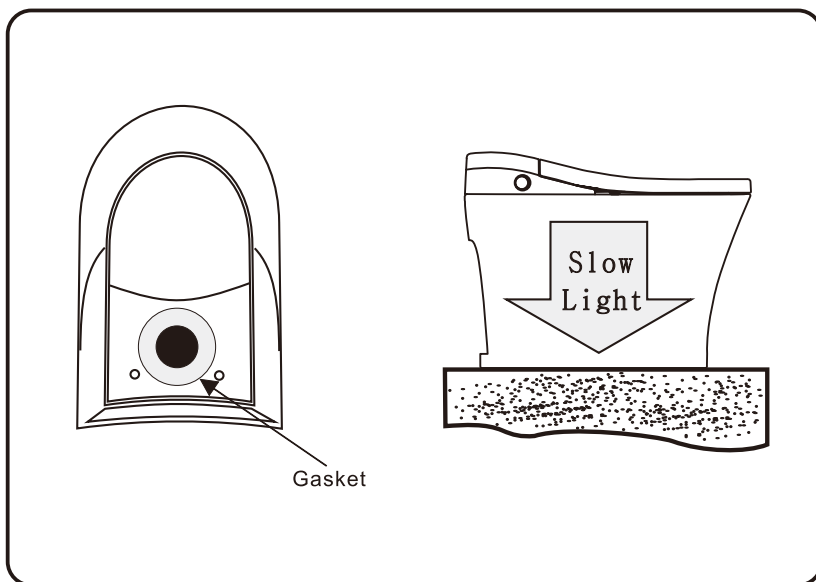

※ Install the Toilet

1. please check the drain outlet is unblocked and the installation floor is clean before installation.
2. Put the matching seal ring on the drain outlet
3. Aim the toilet drain outlet to the drain hole, slowly put the toilet down, adjust the position to make sure that it is hermetic between seal ring and drain outlet.
4. Coat the glass cement around the bottom of toilet.
5. Clean the floor and tools, forbid to use immediately(normally glass cement need 24 hours to solidify), keep the toilet away from water for 24 hours.

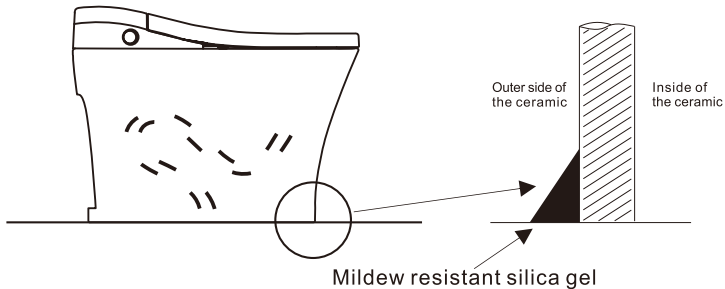

Attentions of toilet installation

1. please do not put cement mortar into the front cavity or any other cavities of the ceramic, it may break the bottom of the toilet when the cement congeal.
2. Please do not flush the newspaper, diaper, sanitary towel or other objects which are easily block the drain outlet.
3. It can not be used under 0°C, otherwise the frozen water may break up the ceramic.
4. To avoid damage and water leakage, please do not impact the ceramic with hard object.
5. To keep the toilet outside surface clean, please use nylon brush, soap-suds or neutral detergent, no steel brush and strong causticity, solution, it may destroy the glaze of the ceramic, erosion the pipeline.

Statement: our company will not be responsible for the losses caused by the listed incorrect installation and actions.

◆ Install the remote controller ◆

■ The following picture shows the installation method

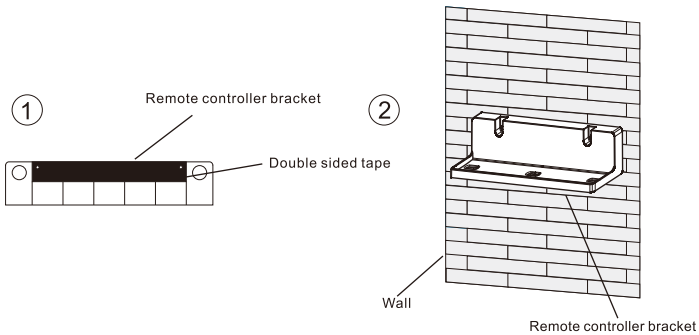

Tear the paper of double sided tape on the back of bracket, stick the bracket on the wall

Notice: Clean the installation position before pasting. Strongly and evenly press the tape when pasting. Use it after 15 minutes.

※ Install the Toilet

1. Remove the toilet seat from toilet bowl.
2. Unscrew water connection hose from the toilet and toilet seat.
3. Placing the seal ring under the toilet.

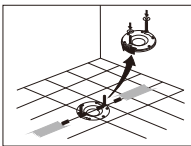

4. Position the toilet onto the floor flange. Make sure the fixing bolts are aligned with the toilet holes.

5. Using a ratchet, tightly screw the nuts to the fixing bolts.

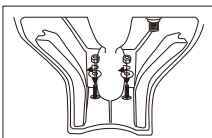
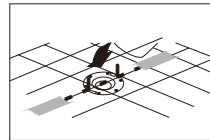













6. Re-install the toilet seat.

Operation

◆ Operation introduction

- ※ The design of this product is mainly controlled by remote control, and the side knob control of the product is supplemented.
- ※ The following just shows function introduction.

 Rear wash	 Dryer	 Strong/Lady care	 Front/Strong wash	 Water temp	 Deodorizer
 Front wash	 Stop	 Weak/Child wash	 Back/One solution	 Seat temp	 Nozzle clean

Remote control

Side knob

Control panel

Indicator light

※ Indicator light & LED display panel may different according to specific model configuration, please refer to actual model.

◆ Preparation

1. Open the angle valve



Switch to this position

2. Confirm power plug is well plugged into the electric outlet and the indicator light is on.

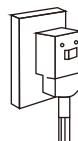

3. After the machine is powered on and initialized, the default is turned on, and the parameters such as water temperature, seat temperature, auto deodorization, and auto flushing are auto restored to the settings before power off.

4. If it is not powered on, press the power button on the side knob to power it on.

◆ How to use

Sit on the seat

Seat Sensor react automatically when sitting on the seat.
Water comes out to pre-wet the inner ceramic bowl.
Deodorizing starts when deodorizer activates automatically.

Water pressure adjustment

4-paragraph for choosing, adjust comfortable water pressure by pressing.



Strong/Lady care Weak/Child wash

Stop

Stop the current cleaning operation. If do not press stop button, rear washing/ front washing will stop automatically after 2minutes.

Nozzle position adjustment

5-paragraph for adjusting the satisfied position to clean by pressing  

Front/Strong wash Back/One solution

Notice: Under oscillating cleaning, the nozzle position adjustment is unavailable

Reminder

The number below the remote control indicator is referenced only for functional instructions and actual remote does not have this number.

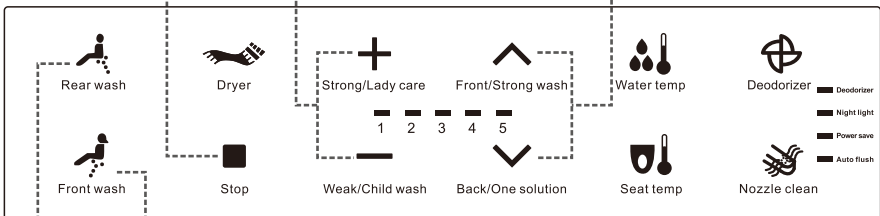

Rear wash

Press , nozzle reaches out to work; Press again change to rear oscillating cleansing, the indicator #1 blink on remote control, nozzle repeatedly swings back or front. Press again, stop oscillating cleansing. Switch back to rear wash.

Front wash

Press , nozzle reaches out to work; Press again change to front oscillating cleansing, the indicator #1 blink on remote control, nozzle repeatedly swings back or front. Press again to stop oscillating cleansing. Switch back to front wash.

Deodorizer

Press this button to start deodorizing, indicator on the remote control lights up. Press again to close.

Nozzle clean

Press  to enter nozzle cleaning, then water flows out and you can clean the nozzle.

- ※ Nozzle clean is effective when people are not seated.
- ※ Nozzle will automatically clean the peripheral part of the nozzle before rear wash and front wash.

Warm air temp adjustment

4-paragraph for choosing, adjust warm air temp by pressing  
Strong/Lady care Weak/Child wash

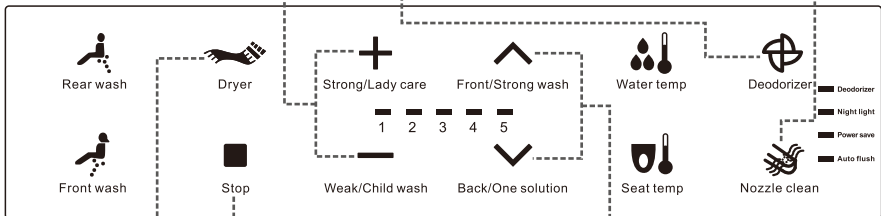

Dryer

Press this button to start warm air drying. Press again change to removable air drying, swings back or front. Press again to stop.

- ※ When you turn on auto flush, smart toilet will flush firstly before you press drying

Dryer position adjustment

5-paragraph for choosing, adjust the dryer position by pressing  
Front/Strong wash Back/One solution

Notice:
Under removable drying, the dryer position adjustment is unavailable

Reminder

Deodorizer will turn off when under drying function. The deodorizer will auto-open when drying finished and it will keep working for 1.5 minutes when people leave the toilet seat.

Stop

Turn off the drying function. Or the warm air will stop automatically after running for 4 minutes.

Lady care

Press this button to enter lady care in idle mode, nozzle reaches out to work and water temp is set to the highest level (39°C), water pressure is set to 2-level, cleaning position set as default.

Water temp/water pressure unadjustable, cleaning position is adjustable in this mode, automatic ends after cleaning for 2 mins. Press  to end.

Stop

Water temp

Press this button to enter water temp adjustment. 4-paragraph for choosing, Normal temp, 1 level, 2 level, 3 level. Normal temp are not heating; 1 level is 33°C, 1 light on; 2 level is 36°C, 3 lights on; 3 level is 39°C, 5 lights on. With each push, water temp change to the next level.



Rear wash



Dryer



Strong/Lady care



Front/Strong wash



Water temp



Deodorizer



Front wash



Stop

Weak/Child wash

Back/One solution



Seat temp



Nozzle clean

-  Deodorizer
-  Night light
-  Power save
-  Auto flush

Child wash

Press this button to enter child wash in idle mode, nozzle reaches out to work and nozzle position is at the front (5 level), mini water pressure (1 level), and the water temp is mid grade (36°C) After washing 30s to end or press  to end.

Stop

Under this mode, cleaning position/ water pressure / water temp are unadjustable.

Seat temp

Press this button to enter seat temp adjustment. 4-paragraph for choosing, Normal temp, 1 level, 2 level, 3 level. Normal temp are not heating; 1 level is 33°C, 1 light on; 2 level is 36°C, 3 lights on; 3 level is 39°C, 5 lights on. With each push, seat temp change to the next level.

Attention: To prevent the low temp scalding, the toilet seat will automatically lowered to below 35°C after sit on the seat for 10 minutes.

One solution

Press this button to start in idle mode, the order is rear wash 40s→oscillate wash 20s→warm air dryer 2 mins→stop. In this mode press  to end.

Stop

Reminder

Idle mode means rear wash, front wash, dryer, flush, etc. are not working.

Child wash, one solution, strong wash, lady care must be enabled in idle mode.

Strong wash

Press this button to enter the powerful washing mode in idle mode, nozzle reaches out to work and the hole starts to effluent. Water pressure is highest level, after washing 2mins to end. Press  to end.

Stop

Power save/off

Press this button, the corresponding indicator blink on remote control in standby, After leaving the seat for 1.5 minutes then enter power saving mode. Under this mode, seat temp is kept at 25°C, and the settings before power saving are automatically restored the next time. Long press 3s to shutdown.

Night light

Press this button to turn on the light, press again to close the light, and the corresponding light on the right will be on or off simultaneously. Repeatable switching.

Flush/Auto flush

Press this button, the corresponding indicator blink on remote control, flush the toilet once. Long press 3s to start auto-flush. After leaving the seat for 5s, auto-flushing the toilet once. Long press again to close.

Attention: When people sit on seat and flush the toilet with remote control or side button. After leaving the seat, auto-flushing will not working.

Power save/Off

Night light

Flush/Auto flush



Rear wash



Dryer



Strong/Lady care



Front/Strong wash



Water temp



Deodorizer



Front wash



Stop



Weak/Child wash



Back/One solution



Seat temp



Nozzle clean

Deodorizer

Night light

Power save

Auto flush

Reminder

After the power on initialized of the machine is complete, the default power on, water temp, seat temp, automatic deodorization, automatic flushing and other parameters automatically return to the settings before power off.

Reminder

Working mode distinction:

- 1.Operation mode: It is in the working state of rear wash, front wash, drying, flushing, nozzle cleaning, etc.
- 2.Idle mode: refers to the idle waiting state in non-operating mode;
- 3.Standby mode: When press the power on the side of the remote controller or side button, the machine enters the standby state, and the power consumption is the lowest.

Product side knob

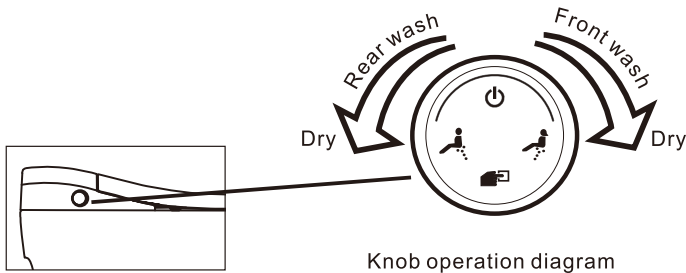

- 1) . In the off state, Knob indicator is not lit, rotate forward/backward/press and other actions will start. Product automatically enters idle mode, indicator shown as light pink, effect; same as breathing light.
- 2) . In idle and off seat mode, functions won't work if rotate forward or backward, indicator shown as light pink;
- 3) . When people sit on the seat, product start working, Knob rotates forward , then turn on automatic front wash function. First wash for 1minute, then warm air dry for 2 minutes; If you rotate forward again during the automatic front wash, stop front wash and turn on the warm air drying function. The indicator light is pink for front wash, red for warm air dry;
- 4) . When people sit on the seat, product start working, knob rotates backwards, then turn on automatic rear wash. First wash for 1 minute, then warm air dry for 2 minutes;If you rotate backward again during the automatic rear wash, stop wash and turn on the warm air drying function. The indicator light is blue for rear wash, red for warm air dry;
- 5) . When people sit on the seat, the product is in the rear wash/ front wash / dry working state, press the knob then the three functions stop, enter idle mode, the indicator is light pink;
- 6) . When the product is on idle or power off mode, press the knob to start flushing. Flushing while in idle mode, indicator light is light red;
- 7) . Continuously press knob two times to start water saving mode (small flush) ;
- 8) . In the power on state, long press the knob for 3s to turn it off, indicator light is off.

Buzzer

Buzz once: Sit on seat condition, all the functions are available.

Buzz twice: Off the seat condition, parts of the functions are available.

Buzz three times or more: There are faults of the product.

Reminder

Buzzer only works when operate on remote controller or side button or initialization.

Control panel



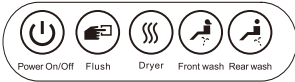

The product design is mainly controlled by the remote control, and the control panel is only the common basic function, as shown bellow picture.



- Key operation is consistent with remote control, details refer to remote control usage
- Water temp & seat temp function set remain last time status when side key operation.
- Only can press the  button to flush when power cut.

Indicator light



Power		Keep lighting, means the power is turn on; The light flashes when the control panel is faulty
Water temperature		Enter water temp setting. The water temp can be adjusted in 4 paragraph, which are normal temp、33°C、36°C、39°C. When the temp in normal, the indicator does not light. In the other 3 files,the indicator lights up; when the water temp heater fails, the light flashes
Seat temperature		Enter seat temp setting. The seat temp can be adjusted in 4 paragraph, which are normal temp、33°C、36°C、39°C. When the temp in normal, the indicator does not light. In the other 3 files, the indicator lights up; when the seat temp heater fails, the light flashes
Seat sensor		Seat sensor response to work, the indicator light is on. When the proximity sensor is active, the seat indication flashes for 3s.
Power saving		Automatic power saving function is turned on, the indicator light is on. When it goes into energy saving mode, only the power indicator and power save indicator lit.

*Foot sensor flush

Operating instruction:

When the foot has crossed the sensor switch at the bottom, the flushing function is activated.

※This function is limited to some models. See the product function table for details.

Reminder: This function doesn't work when seated.



Remote control code matching

If one user has more than two items of the same brand smart toilet, there maybe interaction while using remote control. In this condition, using the remote control code matching function to ensure the uniqueness between the remote control and the toilet. When performing this operation, you must unplug the power of other nearby smart toilets.

1. Plug off the smart toilet power.
2. Press "weak" and "rear" button at the same time, leave it until the indicator light constantly blinking
3. Plug on the smart toilet in 5 seconds.
4. Match code completed when the remote control indicator light stop blinking.

Notice: Remote control match code time is 10s, auto quit if overtime operation

◆ Trouble shooting ◆

SITUATION	REASON	PROCESS
No power	The electrical outlet is not connect to power supply or the plug is not insert to the bottom	Check if the electrical outlet is connected to the power supply; press the reset key on the plug
No water comes out while cleaning	Low pressure of water supply	Raise the water pressure
	Water inlet filter blocked	Remount and clean the filter according to the instruction
Cleansing water in not warm enough	Water temp setting is incorrect	Readjust
Seat does not heat	Seat temp setting is incorrect or the product is in power saving mode	Readjust
Seat and cover are loose	Fixed bolts are loose	Tighten the bolts
Remote controller failure	Battery runs out	Replace battery
No response when pressing the key	Key fault	Reboot or contact ascendant
Water leakage	Shutoff valve, water supply hose and water separator are not well connected	Reconnect

Cleaning and Maintenance

• Toilet bowl cleaning

- ◆ Please make sure the electrical plug is taken out
- ◆ Please use wettish soft cloth to wipe the toilet shelf and seat.
The dirt should be cleaned as soon as possible, if it's difficult to clean, you can use neutral detergent.

• Nozzle Cleaning and Maintenance

- ◆ Press "nozzle clean", nozzle will come out and start auto wash, then you can use brush to clean it.

Attention:
Do not use steel brush to clean

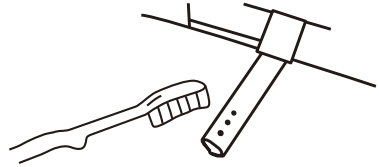

• Cleaning the filter

When the water pressure is too low or insufficient, please clean the filter.

1

Close the angle vale and stop water supply

Notice: Do not remove the filter without closing the angle valve.
---Otherwise water will spray out.

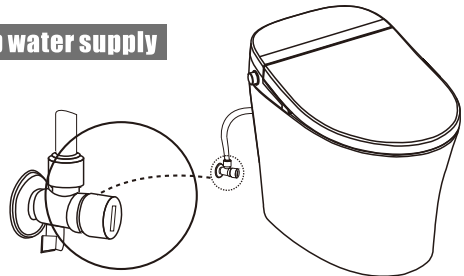

2

Remove the filter

Unscrew the cover of the filter by straight screwdriver and then pull out the cover as below:

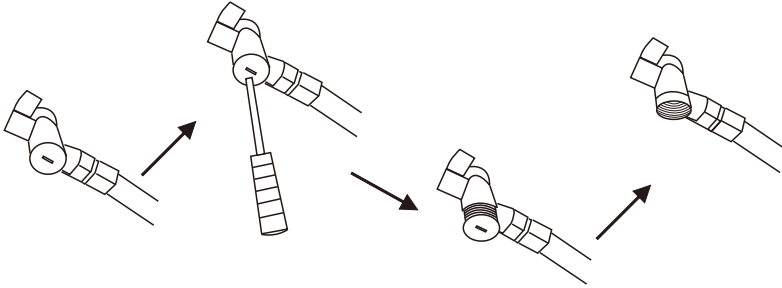

3

Clean the filter

Get the filter out and clean it thoroughly.
-----Flush off dirt or clean the filter by toothbrush

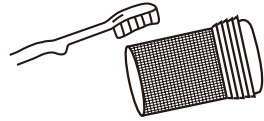

Note: Do not use any cleaning agents. Clean it with water only.
Do not crush the filter when cleaning in case of distortion.

4

Reattach the filter

Reinstall filter based on the removal sequence.

Notice: Open the shutoff valve after installation and confirm there's no water leakage.

• Replace the remote control battery

- ◆ When the battery is running out, the remote controller is sometimes insensitive and sometimes out of control and you should replace the battery at this point

※ **Attention**

The positive and negative poles of the battery must be placed correctly, and the compression spring protrudes from the negative pole.

New and old batteries cannot be mixed

Please use alkaline battery

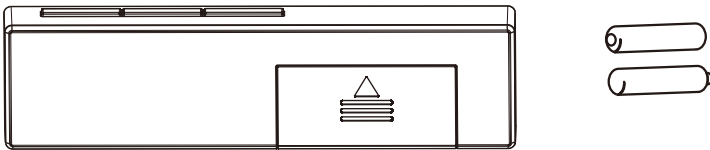

• Replace back up battery

Steps

1. Pull out power plug.
2. Lift toilet seat lid.
3. Take out battery cover.
4. Put battery in right position.
5. Press flush button, be sure it can flush normally.
6. Put cover back and fix toilet seat lid.

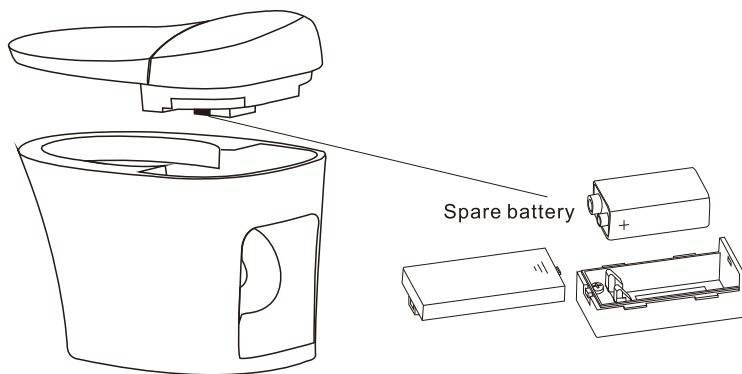

※ Notice

1. The spare battery must use 9V alkaline battery, Do not use carbon or other battery.
2. If the battery is low or not installed, it will cause the flushing to stop normally, and flushing even if power off function will be abnormal.
3. We recommended to check and replace the spare battery every 2 years.
4. Please replace the used batteries and recycle them properly.

Appendix

◆ Product specification ◆

Ambient temp range		4°C-40°C	
Inlet water temp range		5°C-35°C	
Rated voltage		<input type="checkbox"/> AC220V 50Hz	<input type="checkbox"/> AC120V 60Hz
Max power		1680W	1280W
Rated power		1200W	1200W
<small>(Under the condition of 5°C inlet water temp, maximum level of outlet water temp and strength)</small>			
<small>(Inlet water temp: 15°C ±0.5°C)</small>			
Power cord length		1.5m	
Cleansing device	Water pressure range	0.1MPa(dynamic)-0.75MPa(static)(Flow volume is no less than 18L/min)	
	Water pressure adjustment	Adjustable in 4 paragraph	
	Water temp adjustment	4 paragraph adjust: Room temp, 33°C, 36°C, 39°C	
	Safety device	Temp sensor control system、 Dry burning-resistant protection device、 over temp protection system、 water and electricity isolation system	
	Rear wash	0.4-0.6 L/min(water pressure ≥0.15MPa)	
	Front wash	0.4-0.65 L/min(water pressure ≥0.15MPa)	
	Strong wash	0.45 L/min(water pressure ≥0.15MPa)	
Seat heating device	Seat temp control	4 paragraph adjust: Room temp, 33°C, 36°C, 39°C	
	Seat protective system	Temperature sensing control system/ fuse	
Warm air dryer	Warm air temperature	4 paragraph adjustable: 35°C, 42°C, 48°C, 54°C (The wind temp is greatly affected by the environment, and the values are for reference only.)	
	Safety device	Temperature reset switch/fuse	
Deodorizer		Catalyst deodorant box	
Remote control		YES	

Cleaning rate test: In the seated state, the knob is turned to the rear wash for more than 3 seconds to start the wide-width cleaning mode.

◆ Packing list ◆

Dear user

Please check whether the products are complete after you open the box of toilet. Product packaging box containing the items are:

1 Smart toilet

1 Manual

1 Gasket

1 Spanner

1 Angle valve

1 Set remote control (Including remote control, bracket, double side tape,
2 #7 alkaline batteries)

1 9V alkaline battery (6LR61)

Warning

1. This appliance is not intended for use by persons (including children) with reduced physical, sensory or mental capabilities, or lack of experience and knowledge, unless they have been given supervision or instruction concerning use of the appliance by a person responsible for their safety.
2. Children should be supervised to ensure that they do not play with the appliance.
3. If the supply cord is damaged, it must be replaced by the manufacturer, its service agent or similarly qualified persons in order to avoid a hazard.

823ZD (英)